

---

# CAE PERFORMANCE PRODUCTS PTY/LTD

Pyrenees Hwy Chewton, VIC. 3450  
Telephone : ( 03 ) 5472 1442 - Fax ( 03 ) 5472 4111

---

## 46 – 48 Ford Cable Wiper Kit Component List

Wiper Motor Assembly with Flexible Drive Cable (85 Deg Sweep, 900mm Flexible Cable.  
Wiper Mounting Bracket, U Clamp, Rubber.  
Two Small 22 Tooth Wheel boxes, spacers, gaskets, Chrome Nuts and bezels  
Wiring Loom, Switch and In Line Fuse.  
Customer Instruction Sheet

Tubing used is standard 5/16 Steel Brake tubing. ( Bundy Tubing) Do not kink these tubes as serious damage to the wiper motor will occur. **Kink or dented tube must be replaced.** Some gentle bending can be done in a standard tube bender tool to give a better fitment to the cable drive.

### Fitting Instructions

### Cable Driven Wiper Kit

- 1 Location of the Wheel boxes.-- Drill 5/8 clearance hole at the correct angle to give the pressure on the blades. (Should be as close to 90 degrees to the windscreen glass as possible.)

Locate And mark the centre of <sup>C</sup> cowl windscreen opening width, measure out ??mm each side of centre, in the middle of lower radius as shown at a suitable position to give you the 85 degrees of sweep.

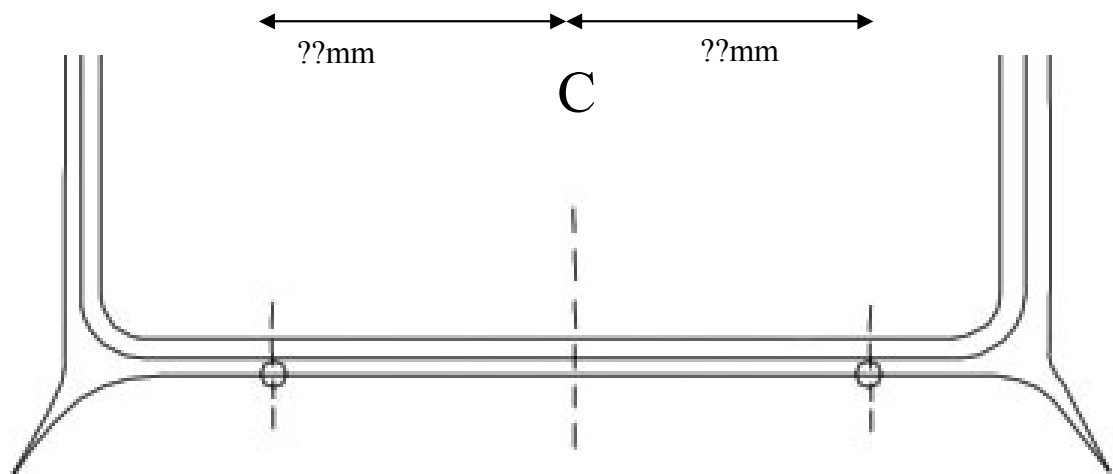

- 2 Fit the two new wheel boxes and **file to shape** the spacer to suit the curvature of the cowl. If you wish to have the park position with both blades in the centre of the windscreen, the one wheel box will be mounted with the tubes and cable at the top of the wheel box, and the other wheel box with the tube and cable on the bottom of the wheel box. (See drawing for correct installation)
- 3 Fit the centre tube between each wheel box and the end tube to the RH Side wheel box, making sure the

---

## CAE PERFORMANCE PRODUCTS PTY/LTD

Pyrenees Hwy Chewton, VIC. 3450  
Telephone : ( 03 ) 5472 1442 - Fax ( 03 ) 5472 4111

---

tube flares fit into the wheel box slots provided. It may be necessary to gently bend the tube slightly to allow correct fitment. Make up a tube from the wiper motor to the First wheel box. It is necessary to fit the Brass Wiper nut over this tube before you flare each end. The length of this tube is determined by where the wiper is mounted in relation to the first wheel box, and the least curve on this tube the quieter the wiper will run.

Grease with suitable wheel grease or silicon grease the entire cable, then feed the Flexible cable thru the first wheel box, support the wiper motor while you mount the first tube into the wheel box and mount the wiper motor bracket to vehicle and the wiper motor to its bracket. **DO NOT STRAIN THE WIPER FIRST TUBE IN ANY WAY. (If the Tubes get any kinks or dents in them they must be replaced or the wiper motor can be seriously damaged.)**

- 4 Fit 2-speed switch in appropriate hole and install wiring loom supplied.
- 5 Connect Brown wire to suitable earth location on the vehicle
- 6 Connect Red feed wire through Fuse supplied to suitable Ignition Feed Wire on Ignition Switch of vehicle. Activate the wiper motor and check for smoothness of operation. Tighten all wheel boxes cover plates. Retest wiper operation.
- 7 Fit original arm or new wiper arm and blades in the park position. It may be necessary to file short the small Allan Grub Screw to be flush with the Knurl.
- 8 Activate power and check wipers for sweep and all body clearances.

# WINDSCREEN WIPERS

Windscreen Wiper Systems ----- Some useful helps.

## 1. Motor

This is a two speed wiper motor, with self parking.

Make sure you use the correct bracket and strap with the rubber covering, and the motor is not touching any part of the vehicle body to eliminate noise.

## 2. Drive Gear

When the new motor arrives there is a threaded brass ferrule to take the first drive tube. There are a couple of gears to fit this motor with the number 100 or 130 which is stamped on the top round plate. This is giving the least amount of travel to the rack and wiper arms.

On the top of the gear plate where the number is stamped there is a drive peg welded in position.

---

## CAE PERFORMANCE PRODUCTS PTY/LTD

Pyrenees Hwy Chewton, VIC. 3450  
Telephone : ( 03 ) 5472 1442 - Fax ( 03 ) 5472 4111

---

This is the only item which changes position throughout all the gears (e.g. welded in different positions on the top plate.). Obviously if this peg was welded to the centre of the plate there would be no travel at all, so the further the peg is positioned to the outer edge of the plate the more travel you get. With each gear come 2 washers and a circlip retains the gear in to the motor, always pack with grease in the gear area before refitting the top cover.

### 3. Wheel Boxes

The wheel box size is 32 teeth on the inner drive wheel and the ideal length of shaft from the inner face to the end of the splines is 2.5 inches. This allows for the thickness of material on fibreglass cars as the first spacer can be cut down in size allowing for varying thicknesses through the bulkhead where the wheel boxes fit.

If the car has a split screen then it is quite easy to fit what was called the clapped hands system. This is by turning one of the wheel boxes through 180 degrees.

Wheelbox showing inner and outer spacer which will require some radius work to suit individual shaped cowls

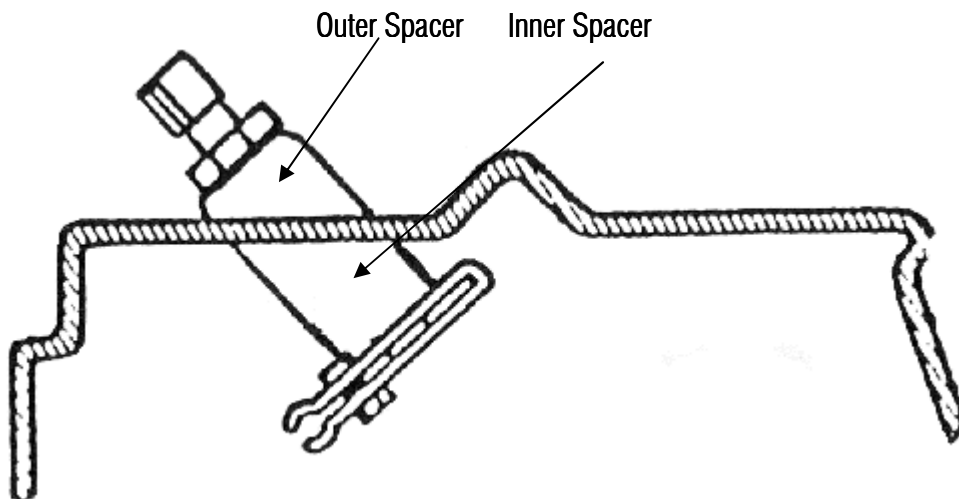

### 4. Drive Rack

When fitting a new system to a existing vehicle, it is advisable to fit a new drive rack as this is one of the items that wears, resulting in the wiper arms having too much play.

---

## CAE PERFORMANCE PRODUCTS PTY/LTD

Pyrenees Hwy Chewton, VIC. 3450  
Telephone : ( 03 ) 5472 1442 - Fax ( 03 ) 5472 4111

---

### 5. Drive or "Bundy" Tubing Sets

It is far better to use the recommended wiper tubing (5/16 Steel Brake Tube) than to use copper tube as this can be noisy and wears very quickly on any bends. Wear of the drive tube, sharp bends or kinks in the tube, causes friction that can lead to the motor burning out.

Bundy tube sets can be made up providing you give the supplier 2 dimensions. The first is the distance from the motor to the centre of the first wheel box hole, and the second the distance between the wheel box hole centres through the bulkhead. Obviously if there is a 3 wiper system then there is another dimension needed. Try to avoid sharp bends in the tubing, If you have to bend the bundy tube, an easy way to form the shape is to insert the drive rack into the tube before bending. This will keep the tube the correct diameter on any of the bends (very much like a plumber bends copper piping by inserting the spring). Always grease the rack liberally before inserting into the bundy tube.

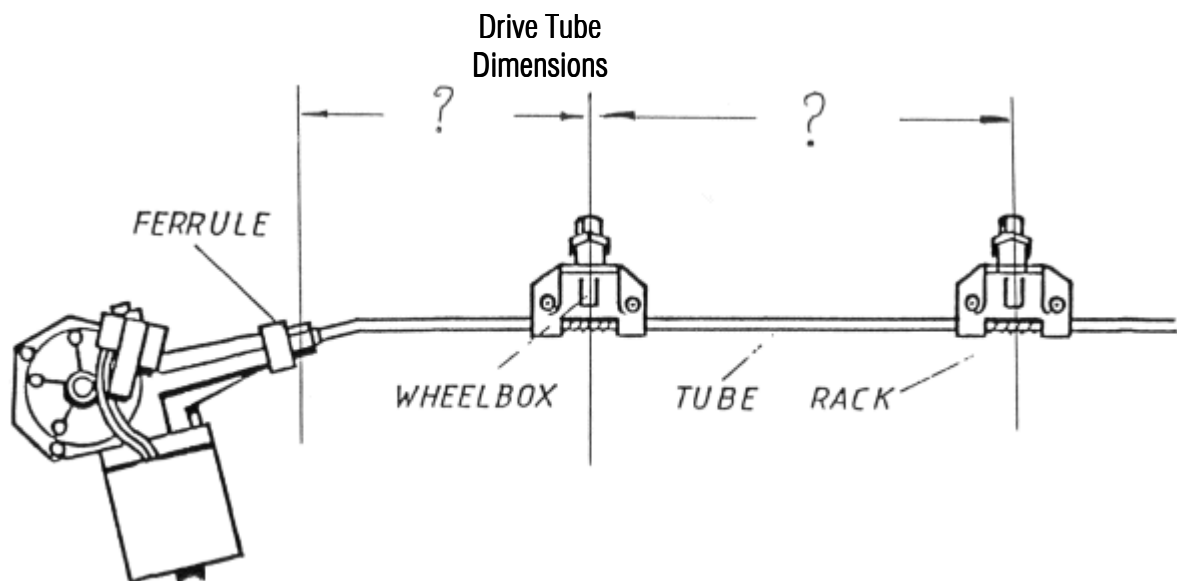

The above diagram is for self parking to be either on the left or the right sides of the windscreen. To have center parking one wheel box is fitted with bundy tubing running to the top of the wheel box. I.E. The wheel box is fitted upside down I.E turned 180 degrees. If the Wiper motor is mounted on the Passenger side then the R.H. Wheelbox is the one that needs to be fitted upside down.

### 6. Switch

It is important that you use the correct wiper 2-speed switch as supplied. The reason for this is that when the switch is in the off position with the ignition switched on there is one connection which becomes live. This operates the parking position. If you use a non-live switch then the wipers would stop whenever the switch was switched off.

If purchasing a second hand motor make sure there are 3 wires going into the motor body. This is the way to tell if the motor is 2-speed, 1 speed only has 2 wires.

---

# CAE PERFORMANCE PRODUCTS PTY/LTD

Pyrenees Hwy Chewton, VIC. 3450  
Telephone : ( 03 ) 5472 1442 - Fax ( 03 ) 5472 4111

---

## Customer Instructions

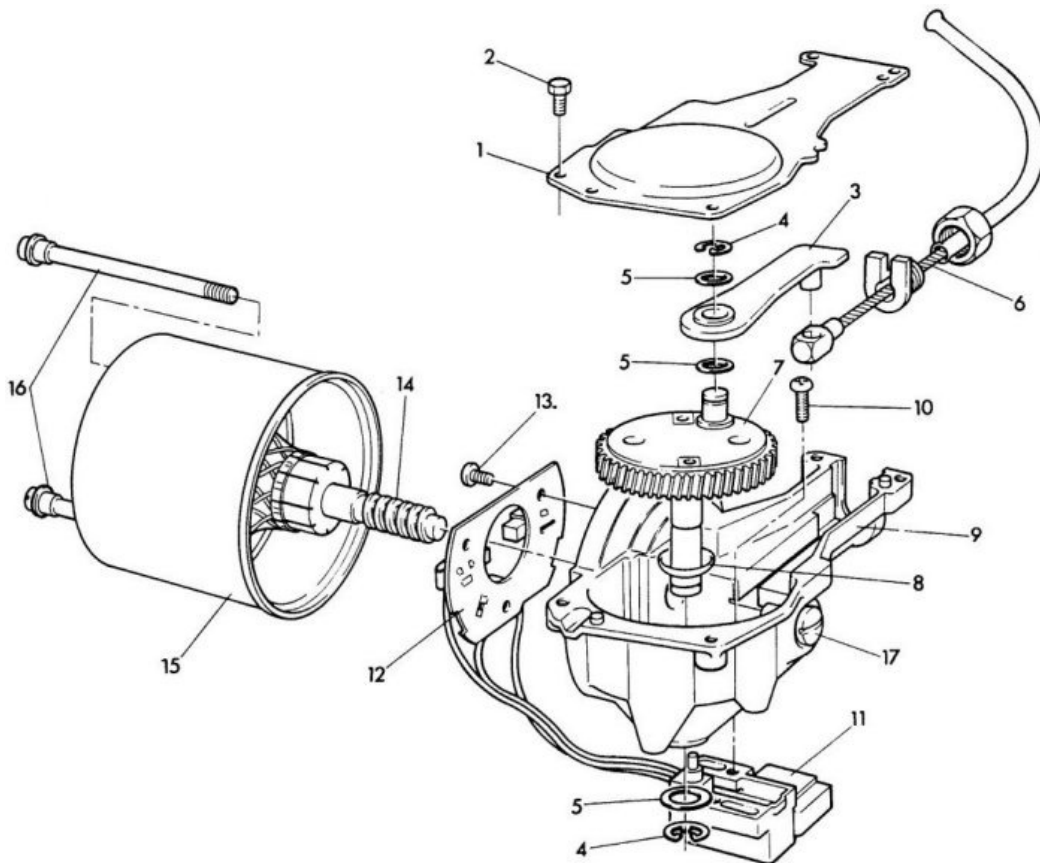

### KEY:

- 1 Gearbox cover
- 2 Screw for cover
- 3 Connecting Rod
- 4 Circlip
- 5 Washers
- 6 Flexible wiper drive

- 7 Gear wheel with crankpin
- 8 Dished washer
- 9 Gearbox
- 10 Limit switch screw
- 11 Limit switch
- 12 Brush gear

- 13 Screw for brushes
- 14 Armature
- 15 Yoke
- 16 Bolts
- 17 Thrust screw



**WIPER KITS**  
Made to your requirements

Price \$550.00 inc gst

---

# CAE PERFORMANCE PRODUCTS PTY/LTD

Pyrenees Hwy Chewton, VIC. 3450  
Telephone : ( 03 ) 5472 1442 - Fax ( 03 ) 5472 4111

---



## WASHER KIT ASSEMBLY 1.2 LITRES

Bottle & pump assembly, mounting bracket, push button switch, tube & a twin Jet.

**\$44.00 inc gst**



## WINDSCREEN WASH PUMP

**\$20.00 inc gst**

Drive Tube (correct material) Cut & flared.

**No Charge**

## Wheelboxes

32 tooth gear wheel.3 1/4 inch drive shaft.

**\$88:00 inc  
gst**

## *Wiper Motor Pin Outs.*

Plugs viewed from the front not the wiring side

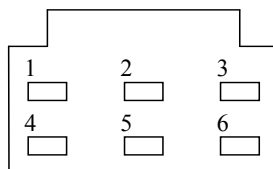

- 1) Black (Earth)
- 2) Green/Red (Low)
- 3) Blue/Red (Park)
- 4) Blank
- 5) Yellow/Blue (High)
- 6) Green/White (+ve)

---

# CAE PERFORMANCE PRODUCTS PTY/LTD

Pyrenees Hwy Chewton, VIC. 3450  
Telephone : ( 03 ) 5472 1442 - Fax ( 03 ) 5472 4111

---

## WIPER MOTOR LOOM PINOUTS

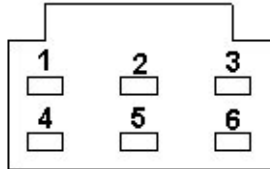

- 1) White - Park
- 2) Blue - Low Speed
- 3) Black - Earth
- 4) Red - 12V Feed
- 5) Green - High Speed
- 6) Blank

6 Pin Female Loom Plug  
As Viewed from the front

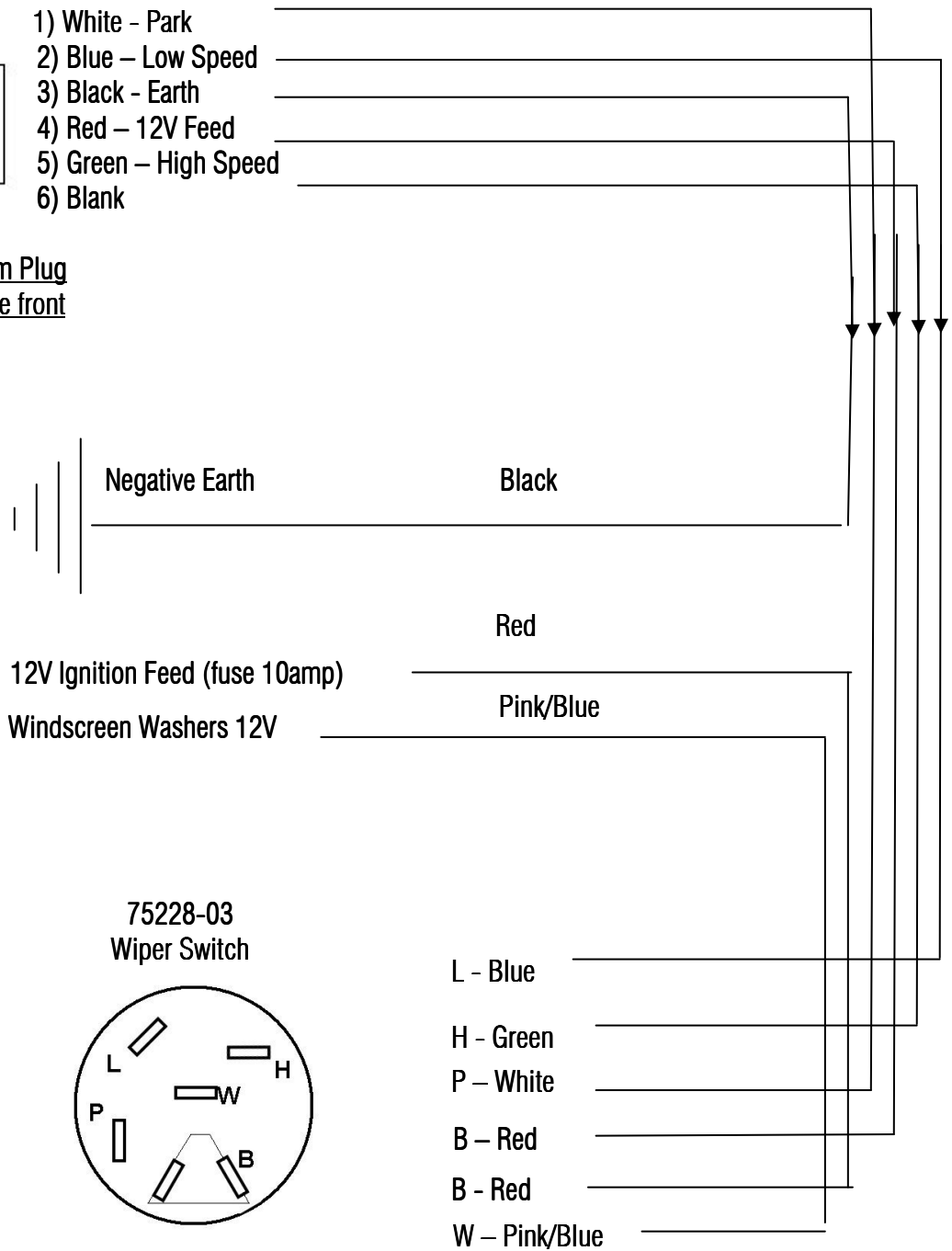

Wiper switch system is 12V Positive Feed