

## CAE PERFORMANCE PRODUCTS

7 MAIN ROAD CASTLEMAINE,  
PO BOX 686 CASTLEMAINE,  
VICTORIA 3450 AUSTRALIA

T 03 5472 1442

F 03 5472 4111

W [www.caepformanceproducts.com.au](http://www.caepformanceproducts.com.au)

E [info@caenterprises.com.au](mailto:info@caenterprises.com.au)

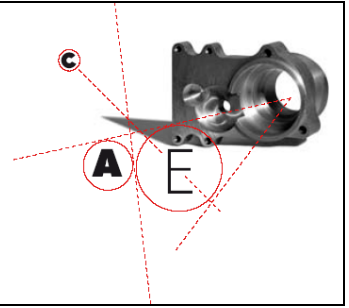

### WIRING INSTRUCTIONS TO SUIT: Universal VS V6+V8 Engine Conversion

Lay the C.A.E Engine loom in vehicle and plug in all the sensors. (The sensor plugs can only be connected one way). Mount the C.A.E Control Loom with the relays and circuit breakers under dash to steel frame or glove box. Making sure that the earth lug with 3 black wires is secured under the mounting bolt.

Using terminals and plugs supplied, adapt original harness to the new loom as per colour codes and numbers on the 6 & 6 pin female plugs that are listed below:

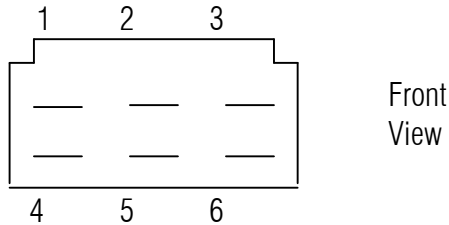

- |                |   |
|----------------|---|
| 1) Red         | - Main cab feed ( positive 50 amp Protection ). |
| 2) Pink        | - Ignition supply (with key in start position). |
| 3) Green       | - Water Temp gauge.                             |
| 4) White\Black | - Alternator light.                             |
| 5) Blue        | - Oil Pressure light.                           |
| 6) Purple      | - Starter motor input signal.                   |

## CAE PERFORMANCE PRODUCTS

7 MAIN ROAD CASTLEMAINE,  
PO BOX 686 CASTLEMAINE,  
VICTORIA 3450 AUSTRALIA

T 03 5472 1442

F 03 5472 4111

W [www.caepformanceproducts.com.au](http://www.caepformanceproducts.com.au)

E [info@caenterprises.com.au](mailto:info@caenterprises.com.au)

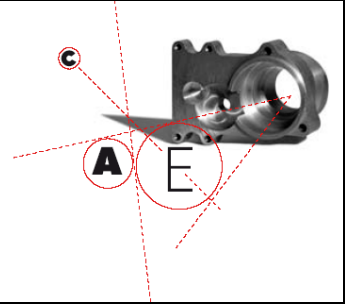

### 1) Battery Supply

This is an auxiliary battery supply, (rated at 50 amps). It can be used for a number of things including power supply to the ignition switch.

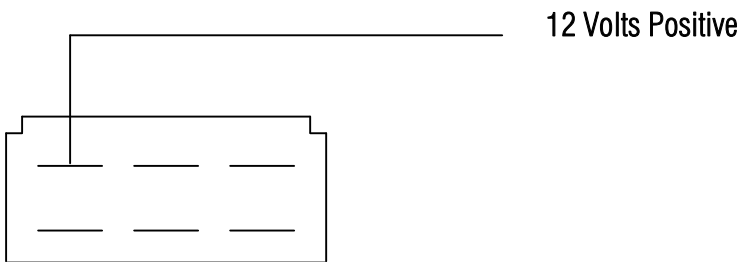

### 2) Ignition Supply

This is to be wired up to the Ignition switch. Make sure that there is 12 volts power when the key is in the ON position, and while the engine is being cranked.

**IF VEHICLE WAS ORIGINALLY FITTED WITH POINTS:**

You will have to find the ignition bypass wire and discard it. (Refer to **NOTE 1**).

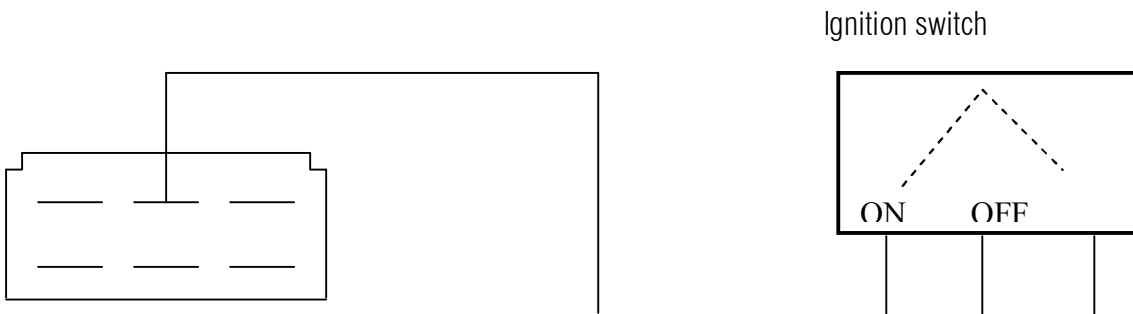

## CAE PERFORMANCE PRODUCTS

7 MAIN ROAD CASTLEMAINE,  
PO BOX 686 CASTLEMAINE,  
VICTORIA 3450 AUSTRALIA

T 03 5472 1442

F 03 5472 4111

W [www.caepformanceproducts.com.au](http://www.caepformanceproducts.com.au)

E [info@caenterprises.com.au](mailto:info@caenterprises.com.au)

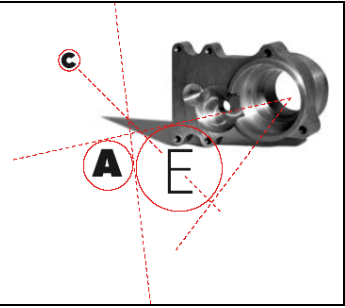

### 3) Temperature Gauge

This is to be wired up to the Temperature gauge, if you are using the original temp Gauge on the vehicle, you will have to change the temp sender to match.

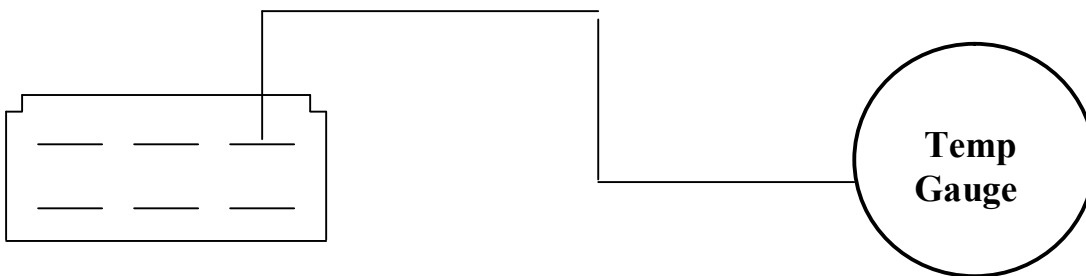

### 4) Alternator Lamp

This is to be wired to alternator warning light.



### 5) Oil Lamp

This is to be wired to Oil warning light.

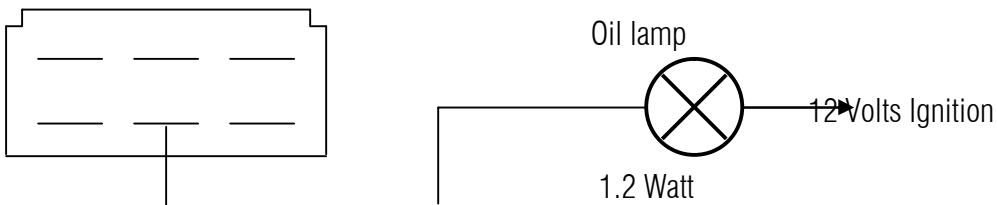

# CAE PERFORMANCE PRODUCTS

7 MAIN ROAD CASTLEMAINE,  
PO BOX 686 CASTLEMAINE,  
VICTORIA 3450 AUSTRALIA

T 03 5472 1442

F 03 5472 4111

W [www.caepformanceproducts.com.au](http://www.caepformanceproducts.com.au)

E [info@caenterprises.com.au](mailto:info@caenterprises.com.au)

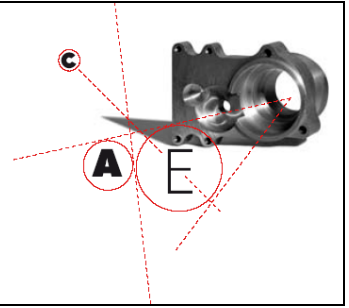

## 6) Starter motor Signal

This is to be wired to the start position on the ignition switch. If using an Automatic Gear box, wire this up through the inhibitor switch first.

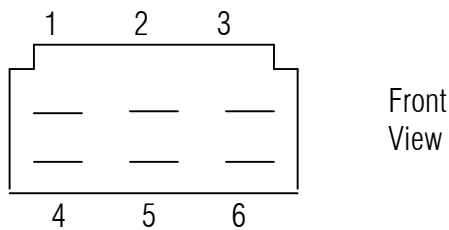
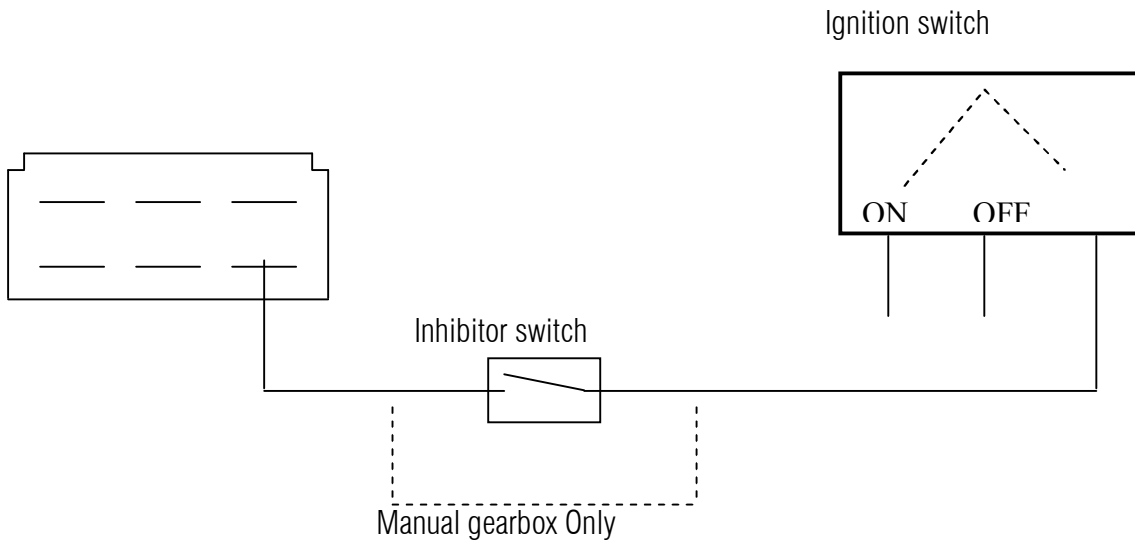

- |                    |      |                            |
|--------------------|------|----------------------------|
| 1) Brown           | 2 mm | - Tacho Signal.            |
| 2) Yellow / White* | 2 mm | - A / C Switch.            |
| 3) White / Brown   | 2 mm | - E.C.M Check Engine Lamp. |
| 4) NOT USED        |      |                            |
| 5) Violet / White  | 2 mm | - Electric Speedo.         |
| 6) White / Red     | 2 mm | - Power / Economy switch.* |

## CAE PERFORMANCE PRODUCTS

7 MAIN ROAD CASTLEMAINE,  
PO BOX 686 CASTLEMAINE,  
VICTORIA 3450 AUSTRALIA

T 03 5472 1442

F 03 5472 4111

W [www.caepformanceproducts.com.au](http://www.caepformanceproducts.com.au)

E [info@caenterprises.com.au](mailto:info@caenterprises.com.au)

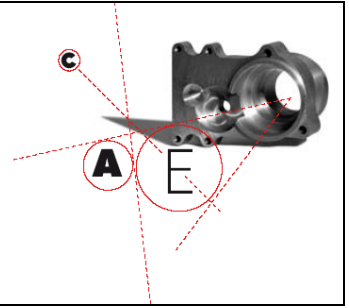

### 1) Tacho Signal

This is to be wired to the tacho signal, on the back of the tacho

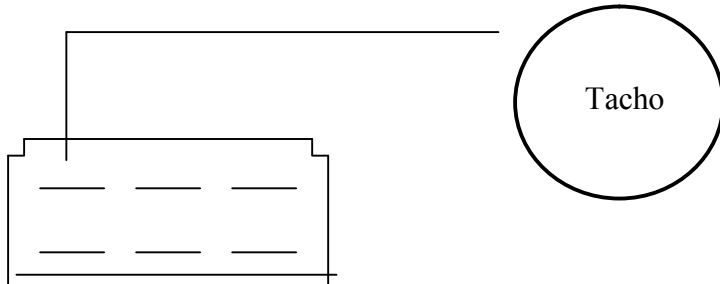

### 2) A / C Switch

This is to be wired up to the A / C switch, through the blower fan. High & low pressure switches, and the E.V.A.P temp switch.

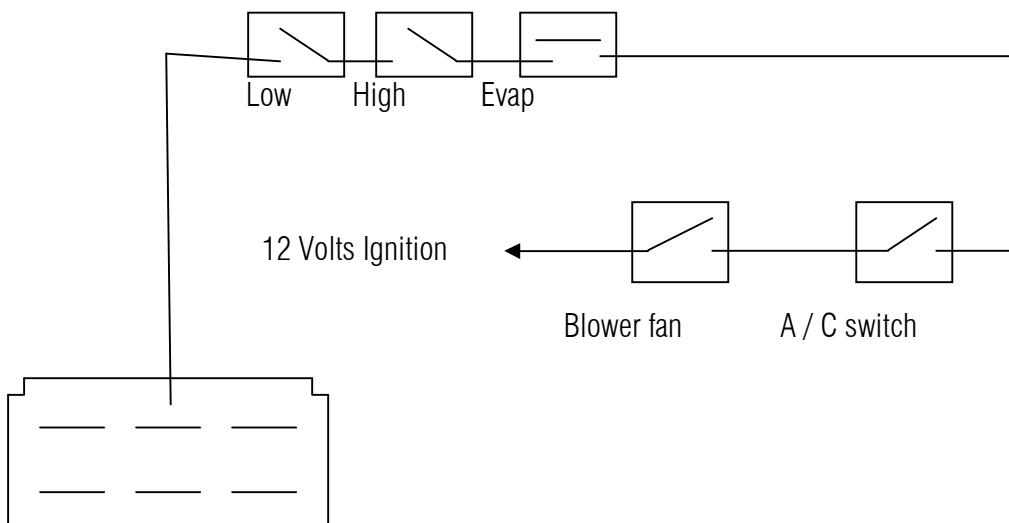

## CAE PERFORMANCE PRODUCTS

7 MAIN ROAD CASTLEMAINE,  
PO BOX 686 CASTLEMAINE,  
VICTORIA 3450 AUSTRALIA

T 03 5472 1442

F 03 5472 4111

W [www.caepformanceproducts.com.au](http://www.caepformanceproducts.com.au)

E [info@caenterprises.com.au](mailto:info@caenterprises.com.au)

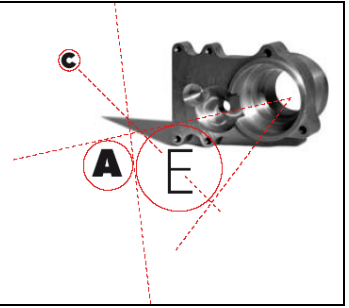

### 3) E.C.M Lamp

This is to wired up to the E.C.M warning lamp,

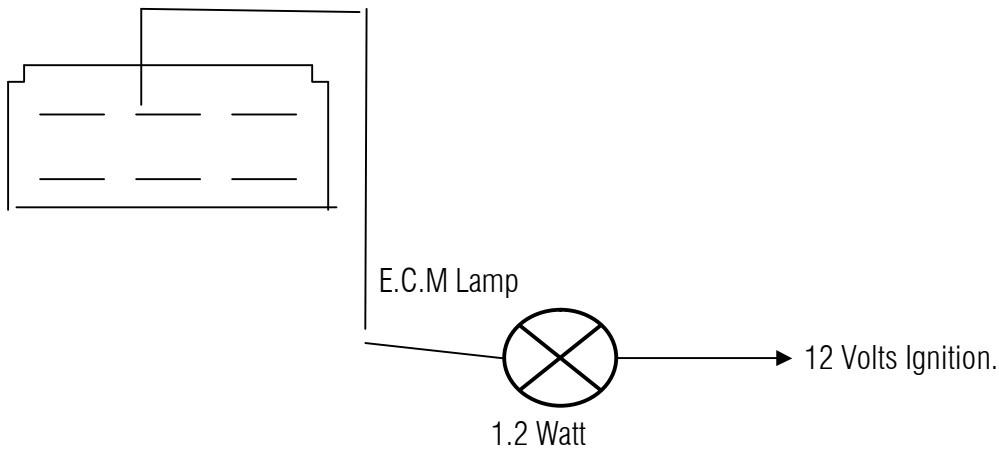

### 4) Reverse Lights – 3mm Grey

This is to wired up to the Reverse lamps,

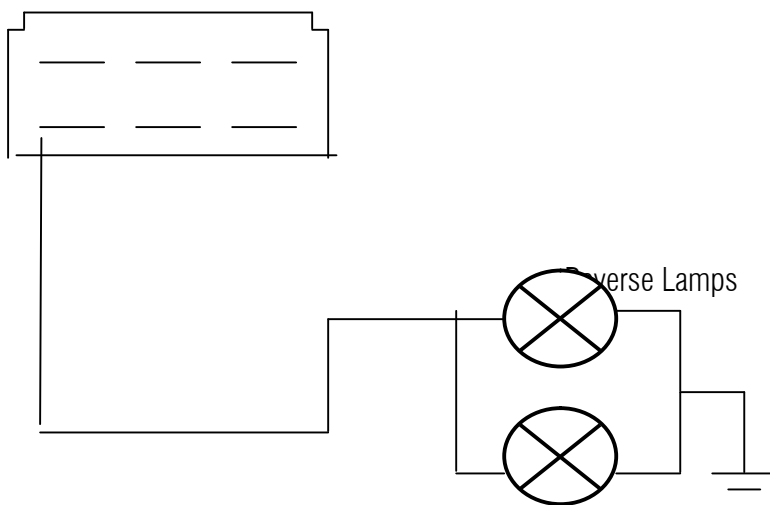

## CAE PERFORMANCE PRODUCTS

7 MAIN ROAD CASTLEMAINE,  
PO BOX 686 CASTLEMAINE,  
VICTORIA 3450 AUSTRALIA

T 03 5472 1442

F 03 5472 4111

W [www.caepformanceproducts.com.au](http://www.caepformanceproducts.com.au)

E [info@caenterprises.com.au](mailto:info@caenterprises.com.au)

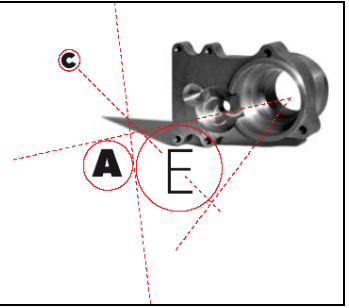

### 5) Speedo Output

This is to be wired up to the Speedo output signal, on the back of the Speedo.  
(Only use if running an electronic Speedo in the dash).

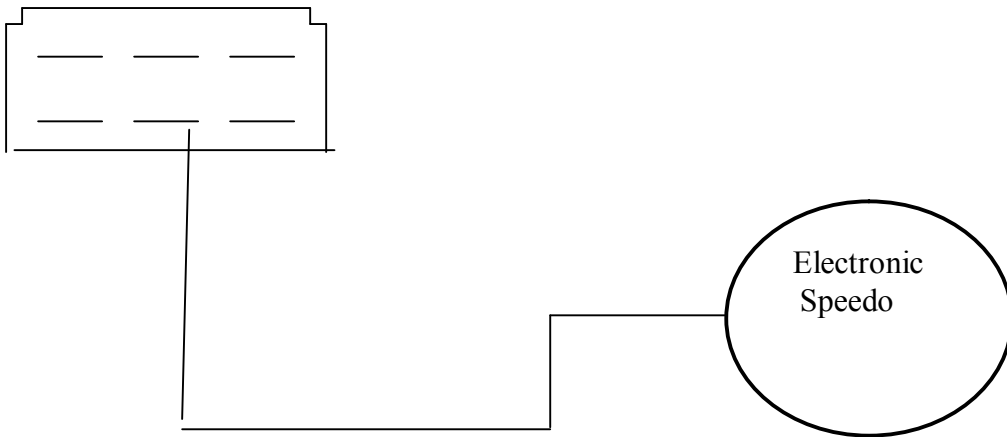

## CAE PERFORMANCE PRODUCTS

7 MAIN ROAD CASTLEMAINE,  
PO BOX 686 CASTLEMAINE,  
VICTORIA 3450 AUSTRALIA

T 03 5472 1442

F 03 5472 4111

W [www.caepformanceproducts.com.au](http://www.caepformanceproducts.com.au)

E [info@caenterprises.com.au](mailto:info@caenterprises.com.au)

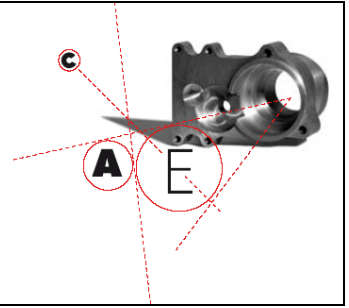

## 6) Power / Econ switch

This is to be hooked up to the power / Econ switch which is mounted in the centre console.

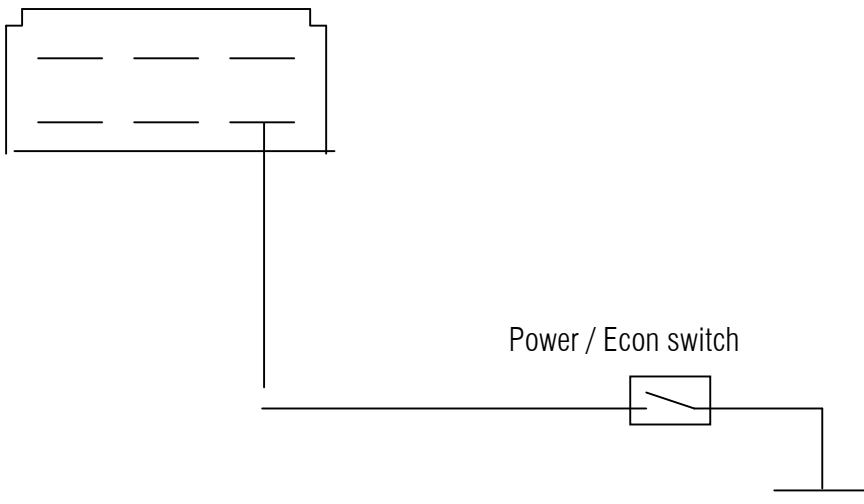

Run the fuel pump wiring down to the fuel pump and connect as follows:  
(Red is positive - Black is negative)

Run the thermo fan wiring down to the front of the radiator and with the 2 pin plug, wire in the fans. Check the direction of the cooling fans. If the fan runs backwards, reverse the wires in the 2 pin plug (red & black)

After final installation of the loom, check that all of the circuit breaker connection are tight.



# CAE PERFORMANCE PRODUCTS

7 MAIN ROAD CASTLEMAINE,  
PO BOX 686 CASTLEMAINE,  
VICTORIA 3450 AUSTRALIA

T 03 5472 1442

F 03 5472 4111

W [www.caepformanceproducts.com.au](http://www.caepformanceproducts.com.au)

E [info@caenterprises.com.au](mailto:info@caenterprises.com.au)

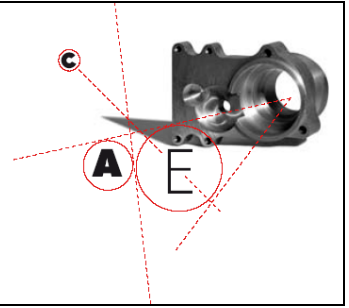

## SPECIAL NOTES.

### Note 1: Ignition Switch By Pass

## Holden HQ-VB & Torana

### Points ignition Bypass Diagram

#### **NOTE!!!!**

If This Process is not Carried out Correctly your Vehicle will fail to run

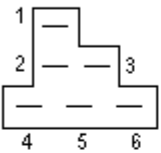

- 1. Violet Starter Motor Solenoid
- 2. Not Used
- 3. Red Battery +ve
- 4. Black Earth
- 5. Pink Ignition 1
- 6. Yellow-White Ignition 2 Resister Wire For Points Ignition

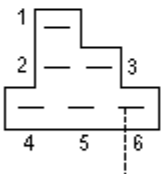

Yellow-White Resister wire That Orignally went to  
Coil +ve With Points ignition setup

This Wire needs to be cut and disregarded

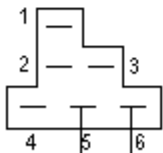

To Cae engine Loom Pink Pin 2

Pin 5 Pink Ignition 1 and Pin 6 ignition 2 need to be looped together and a new wire to be ran out and connected to Cae Engine Loom as shown. This will enable the Cae loom to have a true ignition voltage and not have a voltage of 8volt caused by the resister wire

## CAE PERFORMANCE PRODUCTS

7 MAIN ROAD CASTLEMAINE,  
PO BOX 686 CASTLEMAINE,  
VICTORIA 3450 AUSTRALIA

T 03 5472 1442

F 03 5472 4111

W [www.caeperformanceproducts.com.au](http://www.caeperformanceproducts.com.au)

E [info@caenterprises.com.au](mailto:info@caenterprises.com.au)

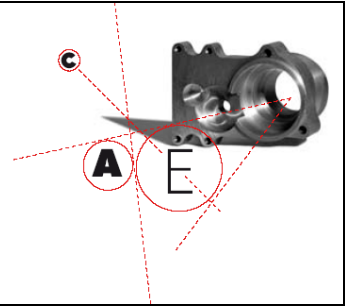

## Holden EJ EH HR HD HK HG HT

### Points Ignition Bypass Diagram

#### **NOTE!!!!**

If This Process is not Carried out Correctly your Vehicle will fail to run

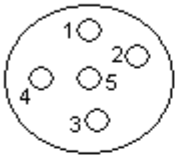

- 1. Red      Batter +ve
- 2. Brown    Accessories
- 3. Pink      Ignition 1
- 4. White    Ignition 2 Resister
- 5. Violet    Starter Solenoid

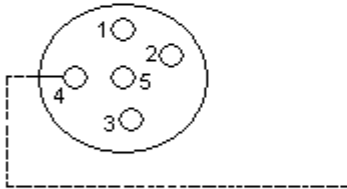

White Resister wire That Orignally went to  
Coil +ve With Points ignition setup

This Wire needs to be cut and disregarded

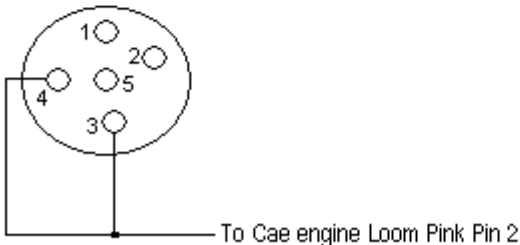

Pin 3 Pink Ignition 1 and Pin 4 ignition 2 need to be looped together and a new wire to be ran out and connected to Cae Engine Loom as shown. This will enable the Cae loom to have a true ignition voltage and not have a voltage of 8volt caused by the resister wire

## CAE PERFORMANCE PRODUCTS

7 MAIN ROAD CASTLEMAINE,  
PO BOX 686 CASTLEMAINE,  
VICTORIA 3450 AUSTRALIA

T 03 5472 1442

F 03 5472 4111

W [www.caepformanceproducts.com.au](http://www.caepformanceproducts.com.au)

E [info@caenterprises.com.au](mailto:info@caenterprises.com.au)

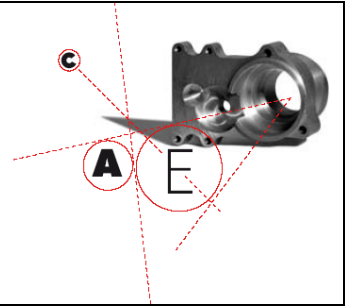

### Note 2: If Engine does not start.

- 1) Do you have fuel pressure?
- 2) Do you have Hi Tension Spark?
- 3) Do you have Injection Pulse?
- 4) Check Pin 2 on Control loom Ignition feed with test light and with the Ignition switched on and with the Engine cranking over the test light should stay on at all times.  
If light fails to glow, go back to Note 1 and recheck ignition bypass.

Due to shortage of wire colours at times, there may be some wire colours that don't match. If this is the case follow the plug configuration.

**CAE PERFORMANCE PRODUCTS**

7 MAIN ROAD CASTLEMAINE,  
PO BOX 686 CASTLEMAINE,  
VICTORIA 3450 AUSTRALIA

T 03 5472 1442

F 03 5472 4111

W [www.caepformanceproducts.com.au](http://www.caepformanceproducts.com.au)

E [info@caenterprises.com.au](mailto:info@caenterprises.com.au)

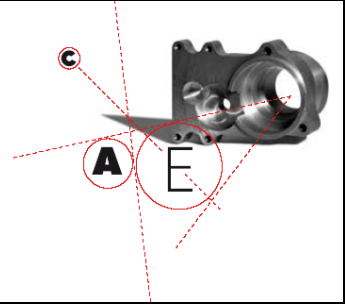

## C.A.E. PERFORMANCE PRODUCTS PTY LTD LOOM WARRANTY

### Manufacturer's Warranty:-

All Looms manufactured or modified by C.A.E. Performance Products Pty Ltd will be guaranteed against faulty workmanship for a period of twelve months.

The warranty is subject to the following conditions:-

- All claims must be made within the warranty period.
- Any loom manufactured or modified that has been found to have faulty workmanship or related faults due to the workmanship of C.A.E. Performance Products will be replaced or repaired free of charge.
- C.A.E Performance Products recommend that this product be fitted by qualified personnel.
- The warranty will not apply to a loom that has been installed incorrectly or has been subject to neglect, intentional or accidental damage, unauthorized repairs or modifications or used for the wrong application.
- The warranty does not cover installation or removal of wiring loom or freight costs.
- The warranty will only apply to wiring looms used for normal road use.